

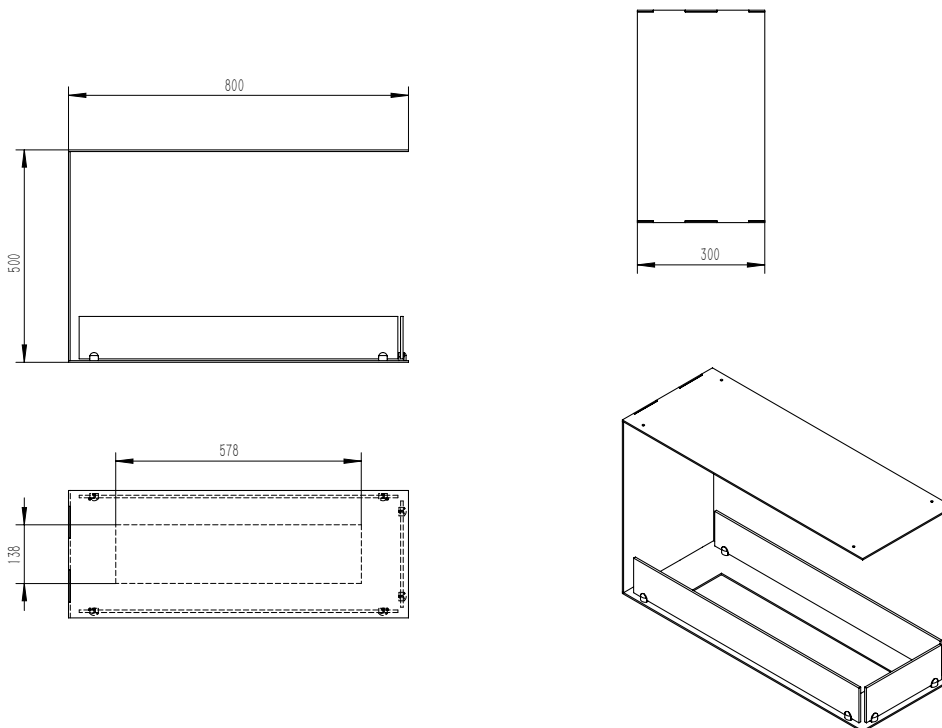

Foco Room Divider 800 Medium

BIO-30-143 (Manual Burner)



TECHNICAL SPECIFICATIONS

Type	Built-in Bioethanol Fireplace
Size	Height: 500 mm Width: 800 mm / Depth: 300 mm (Height with burner: 580 mm)
Materials	Steel
Weight	Approx. 20 kg
Burner	Adjustable Manuel bioethanol burner (Burner width: 600 mm / Flame width: 450 mm)
Capacity	3.5 Liter
Usage	Approx 0.46 L/h - Up to 7h30m per filling
Fuel	Bioethanol (Recommended 96,6% alcohol)
Colour	Black
Heat Output	3.28 kW
Electricity	No



Foco Room Divider 800 Medium

BIO-30-143 (Automatic Burner)

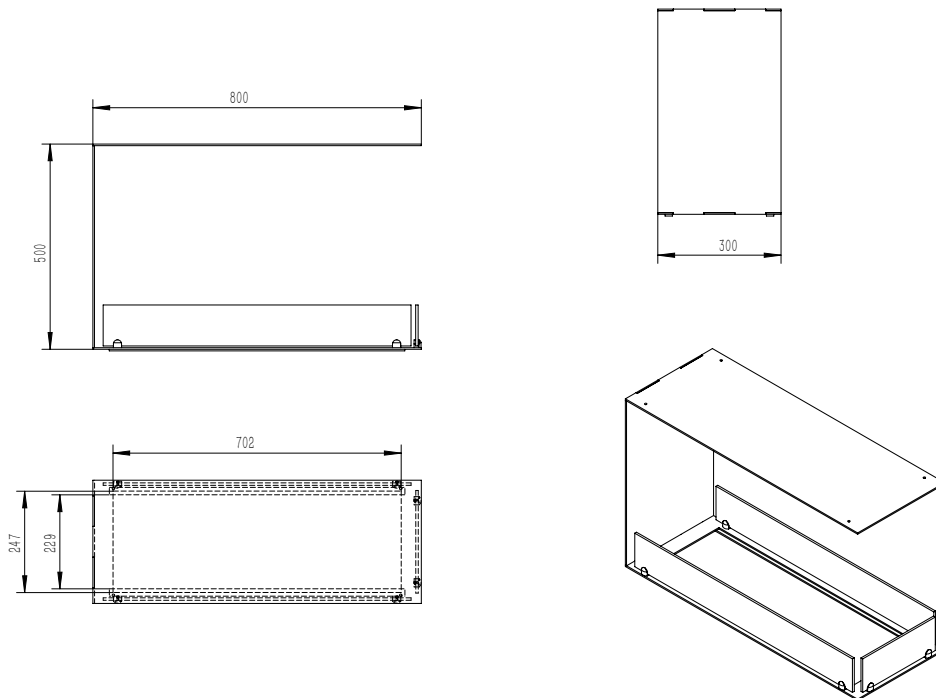

TECHNICAL SPECIFICATIONS

Type	Built-in Bioethanol Fireplace
Size	Height: 500 mm Width: 800 mm / Depth: 300 mm (Height with burner: 645 mm)
Materials	Steel
Weight	Approx. 30 kg
Burner	Planika PrimeFire 700 - Automatic Burner
Capacity	2.0 Liter
Usage	Approx 0.30 - 0.50 L/h - Max 6h30m per filling
Fuel	Bioethanol (Recommended Fanola Premium)
Colour	Black
Heat Output	1.9 - 3.1 kW
Electricity	Yes